

# SIGANMETRIC

artificial bio intelligence

SIGAN SM77FB

biometric time attendance system

biometric  
identification  
and  
recognition  
systems

the face value

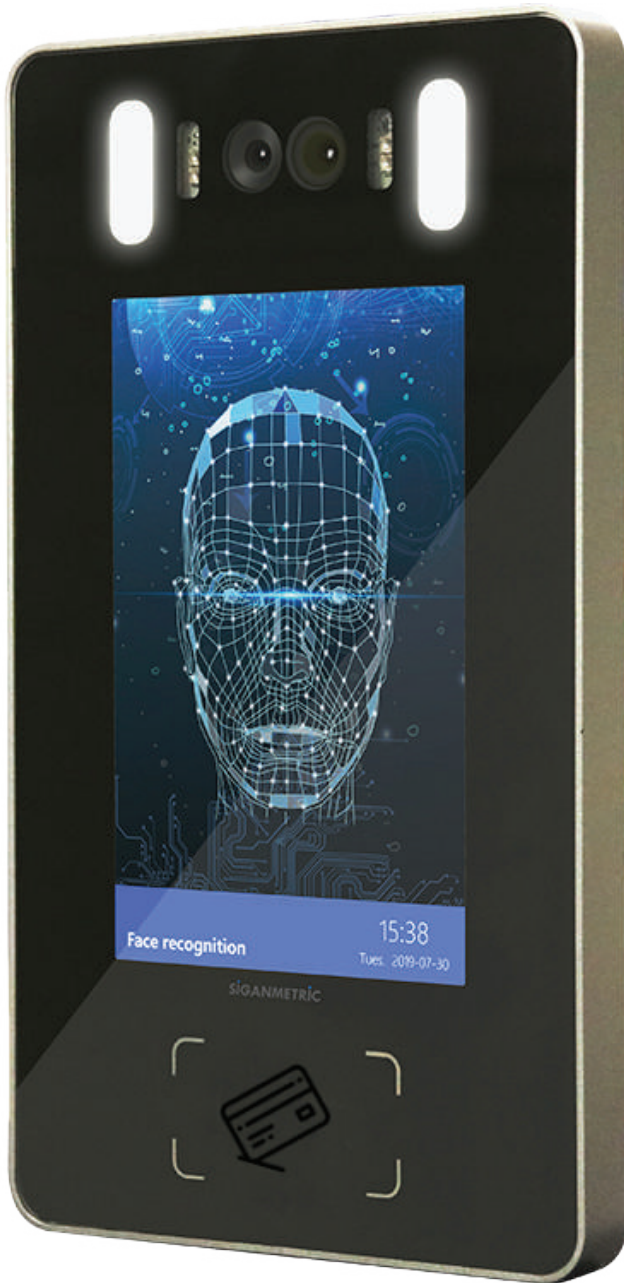

Face recognition



Proximity card



Indoor/ Outdoor use





















Time attendance

BASED ON DEEP LEARNING ARTIFICIAL INTELLIGENCE

FACE + PROXIMITY



|  |  |   |   |   |  |
|--|--|---|---|---|--|
|  | <b>Processor</b><br>Dual Core Processor,<br>Main frequency 1 GHz |  | <b>Operating system</b><br>Embedded LINUX                     |  | <b>Weather rating</b><br>IP 64, RH 90%<br>Temperature -40°C-65°C |
|  | <b>Main camera</b><br>2MP, 1/2.8"<br>Progressive Scan CMOS       |  | <b>Power supply</b><br>12VDC, 3.0A<br>Consumption 20Watt(max) |  | <b>Protocol</b><br>Wiegand (WG26, WG34)<br>I/O, relay out        |
|  | <b>Lens focal length</b><br>4mm                                  |  | <b>Network</b><br>RJ45 10M/100M adaptive<br>Ethernet port     |  | <b>Face records library</b><br>5000/10000/20000                  |
|  | <b>Video compression</b><br>H.264 software compression           |  | <b>USB port</b><br>USB 1.0, USB 2.0(optional)                 |  | <b>Face recognition records</b><br>160,000                       |
|  | <b>Display</b><br>IPS 7 Inch TFT monitor                         |  | <b>Edge storage capacity</b><br>DDR 512M, Flash 8GB           |  | <b>MTBF</b><br>Mean Time Between<br>Failures 50,000 hours        |
|  | <b>Recognition time</b><br>less than 0.7 seconds                 |  | <b>Bracket type</b><br>Wall mount, Column type                |  | <b>PROXIMITY CARDS</b><br>EM, Mifare<br>5000 Users               |

| SPECIFICATIONS    |             | SIGAN SM77FB5   | SIGAN SM77FB7    | SIGAN SM77FB8    |       |               |
|-------------------|-------------|---|------------------|------------------|-------|---------------|
| Algorithm         |             | Artificial Intelligence, Deep Learning  |                  |                  |       |               |
| CPU               | Processor   | Dual Core Processor, Main frequency 1 GHz   |                  |                  |       |               |
| Memory            | DDR         | 512M  |                  |                  |       |               |
|                   | Flash       | 8G  |                  |                  |       |               |
| Camera            | Pixels      | Sensor  | Focal length     | Aperture         | WDR   | Viewing angle |
| Visible           | 2MP         | 1/2.7"  | 4mm              | F 2.4            | 110dB | 90°           |
| Infra Red         | 2MP         | 1/5"  | 4mm              | F 2.5            | 105dB | 88°           |
| Screen Type       |             | LCD   |                  |                  |       |               |
| Resolution        |             | 1280 x 800  |                  |                  |       |               |
| Size              |             | 7 inch  |                  |                  |       |               |
| Records           | Users       | 5000  | 20000            | 20000            |       |               |
|                   | Events      | 70000   | 200000           | 200000           |       |               |
| Card format       |             |   | Mifare/ EM       |                  |       |               |
| Integration       | Input       | Wiegand 26/34 x 1, Reader module built-in x 1, Exit button x 1,<br>Door alarm magnet x 1, Alarm interface relay input x 1 |                  |                  |       |               |
| Communication     | Output      | 2 x Relay output interface, 1 x Wiegand<br>TCP/ IP  |                  |                  |       |               |
| Material          | Casing      | ABS / PC  | Turnstile stand  |                  |       |               |
|                   | Rear        | Aluminum alloy  | Aluminum alloy   | Aluminum alloy   |       |               |
|                   |             | Galvanized sheet  | Galvanized sheet | Galvanized sheet |       |               |
| Dimensions(HWT)mm |             | 261 x 126 x 33  | 275 x 156 x 35   | 275 x 156 x 39   |       |               |
| Installation      |             | Wall mount/ Surface mount (using customized brackets)   |                  |                  |       |               |
| Outdoor rating    |             | IP 65   | IP66             | IP66             |       |               |
| Power             | Voltage     | DC 12 V +/- 5%  |                  |                  |       |               |
|                   | Current     | > 3A  |                  |                  |       |               |
| Environment       | Temperature | -40°C ~ 65°C  |                  |                  |       |               |
|                   | Humidity    | 10 ~ 90%  |                  |                  |       |               |

## DRAWINGS

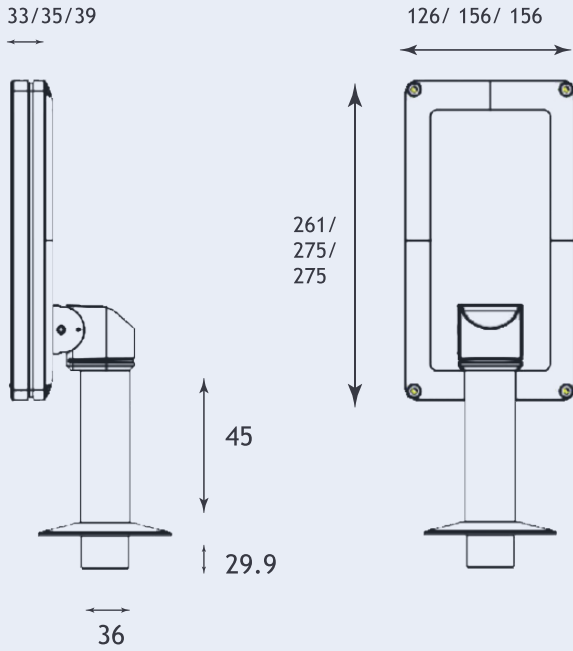

dimensions (mm)/ weight (grams)

|               |                                   |
|---------------|-----------------------------------|
| SIGAN SM77FB5 | 261 (H) x 126 (W) x 33 (T) / 2400 |
| SIGAN SM77FB7 | 275 (H) x 156 (W) x 35 (T) / 2800 |
| SIGAN SM77FB8 | 275 (H) x 156 (W) x 39 (T) / 3100 |

## OPERATION

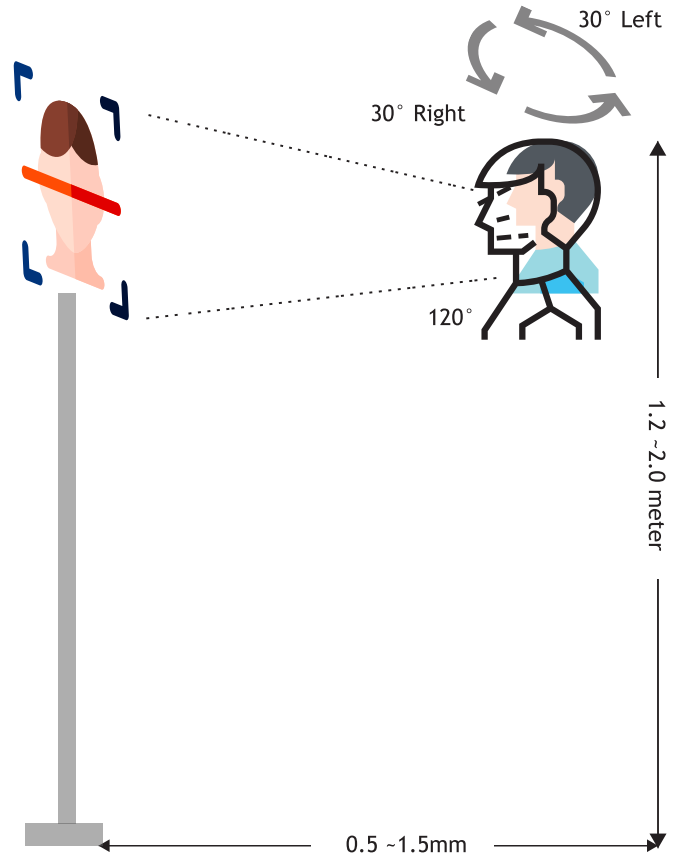

## ordering nomenclature

|               |  |
|---------------|--|
| SIGAN SM77FB5 | Biometric face time attendance. IP 65 rated, Indoor    |
| SIGAN SM77FB7 | Biometric face time attendance. IP 65 rated, turnstile |
| SIGAN SM77FB8 | Biometric face time attendance. IP 65 rated, Standard  |

specifications & product design subject to change without prior notice

SIGANMETRIC artificial bio intelligence

# SIGANMETRIC

artificial bio intelligence



www.sigametric.com