

SIGANMETRIC

artificial bio intelligence

SIGAN SM55FB

biometric time attendance system

biometric
identification
and
recognition
systems

the face value

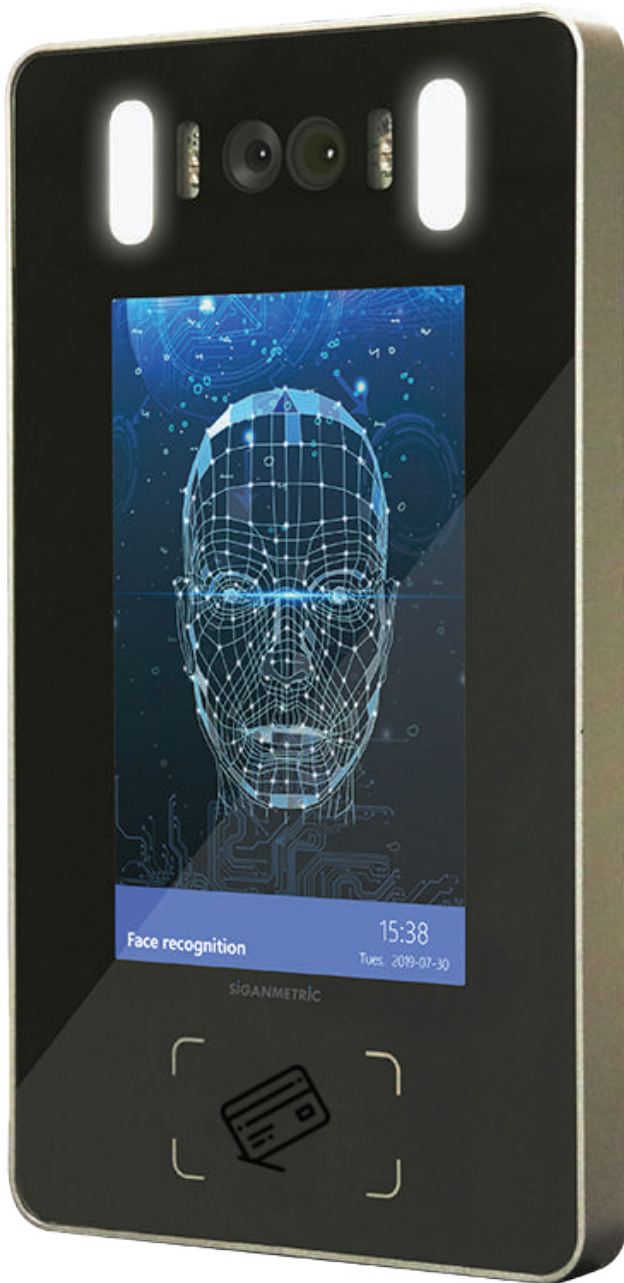

Face recognition



Proximity card



Indoor/ Outdoor use



Time attendance



















BASED ON DEEP LEARNING ARTIFICIAL INTELLIGENCE

FACE + PROXIMITY



SIGANMETRIC

SIGAN SM 55FB

	Processor Dual Core Processor, Main frequency 1 GHz		Operating system Embedded LINUX		Weather rating IP 64, RH 90% Temperature -40°C-65°C
	Main camera 2MP, 1/2.8" Progressive Scan CMOS		Power supply 12VDC, 3.0A Consumption 20Watt(max)		Protocol Wiegand (WG26, WG34) I/O, relay out
	Lens focal length 4mm		Network RJ45 10M/100M adaptive Ethernet port		Face records library 5000/10000/20000
	Video compression H.264 software compression		USB port USB 1.0, USB 2.0(optional)		Face recognition records 160,000
	Display IPS 5 Inch TFT monitor		Edge storage capacity DDR 512M, Flash 8GB		MTBF Mean Time Between Failures 50,000 hours
	Recognition time less than 0.7 seconds		Bracket type Wall mount, Column type		PROXIMITY CARDS EM, Mifare 5000 Users

SPECIFICATIONS		SIGAN SM55FB5			SIGAN SM55FB7	
Algorithm		Artificial Intelligence, Deep Learning				
CPU	Processor	Dual Core Processor, Main frequency 1 GHz				
Memory	DDR	512M				
	Flash	8G				
Camera	Pixels	Sensor	Focal length	Aperture	WDR	Viewing angle
Visible	2MP	1/2.7"	4mm	F 2.4	110dB	90°
Infra Red	2MP	1/5"	4mm	F 2.5	105dB	88°
Screen type		LCD				
Resolution		1280 x 800				
Size		5 inch				
Records	Users	5000				
	Events	100000				
Card format		Mifare/ EM				
Integration	Input	Wiegand 26/34 x 1, Reader module built-in x 1, Exit button x 1,				
	Output	Door alarm magnet x 1, Alarm interface relay input x 1				
Communication		2 x Relay output interface, 1 x Wiegand TCP/ IP				
Material	Casing	ABS / PC			Aluminum alloy	
	Rear	Aluminum alloy			Galvanized sheet	
		Galvanized sheet			Galvanized sheet	
Dimensions(HWT)mm		238 x 104 x 26			217 x 95 x 32	
Installation		Wall mount/ Surface mount (using customized brackets)				
Outdoor rating		IP 64			IP64	
Power	Voltage	DC 12 V +/- 5%				
	Current	> 3A				
Environment	Temperature	-40°C ~ 65°C				
	Humidity	10 ~ 90%				

DRAWINGS

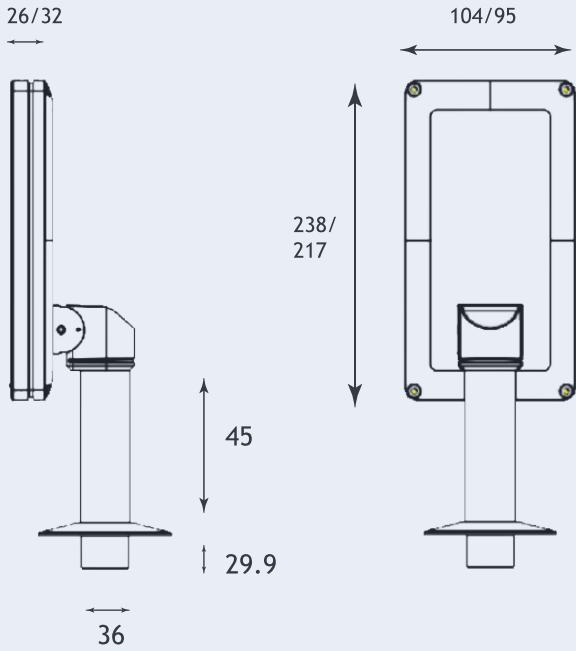

dimensions (mm)/ weight (grams)

SIGAN SM55FB5	238 H x 104 W x 26 T / 2200
SIGAN SM55FB7	217 H x 95 W x 32 T / 1900

OPERATION

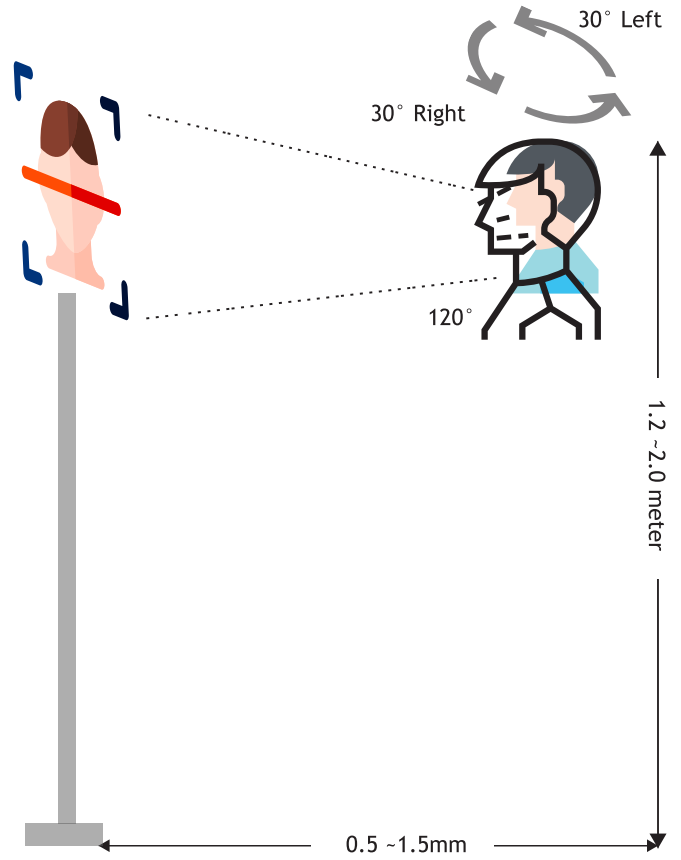

ordering nomenclature

SIGAN SM55FB5	5 Inch display, Biometric face time attendance, IP 64, PC casing
SIGAN SM55FB7	5 inch display, Biometric face time attendance, IP 64, Metal casing

SIGANMETRIC

artificial bio intelligence



specifications & product design subject to change without prior notice

SIGANMETRIC artificial bio intelligence

www.siganmetric.com